

KARIBAN

K4031

Ecologische damessweater met capuchon en ritssluiting

- Modieus en milieuvriendelijk.
- Gemaakt van 3 LSF-draden (Low Shrinkage Fleece): sterk en wasbestendig
- No label: 100% personaliseerbaar naar uw merk.

85% katoen / 15% polyester. Gemaakt van 85% biologisch katoen en 15% gerecycled polyester post-consumer. Buitenoppervlak 100% gekamd katoen. Geborsteld fleece 3 draden LSF (Low Shrinkage Fleece) aan de binnenkant. Enzymgewassen. Rechte snit. Kangeroezakken. Ritssluiting in toon-op-toon nylon. Gevoerde capuchon 100% katoen, jerseykatoen 180 g. 1x1 ribboord in buisconstructie voor een betere afwerking aan de mouwuiteinden en de onderkant. Nektape in toon-op-toon jersey en halvemaanvormige afwerking aan de binnenkant van de kraag. Afwerking dubbel stiksel aan mouwuiteinden, onderkant en hals. Geen merklabel in de kraag, maar enkel een maatlabel voor eenvoudige personalisatie.

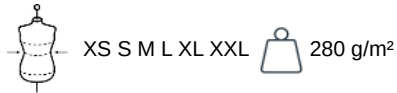

Certificaten



Aanvullende informatie

Logistieke informatie



BD - Bangladesh

HS-codes



61102099

Bestaat ook in



K4030

KARIBAN

K4031

Ecologische damessweater met capuchon en ritssluiting

Afmeting

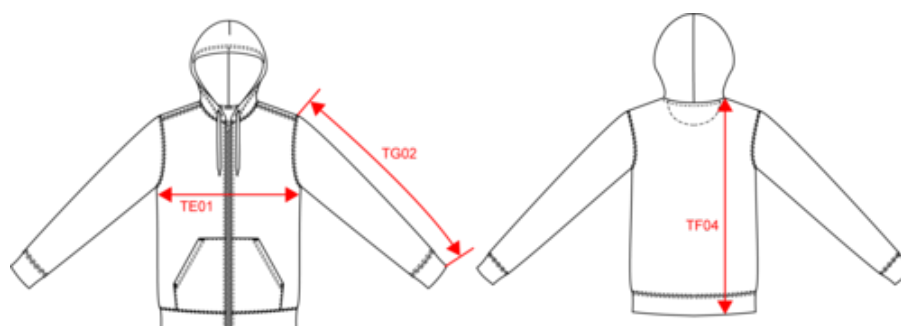













Measurements in cm	XS	S	M	L	XL	XXL
TE01 - 1/2 chest width at 1.5cm below armhole	45.00	48.00	51.00	54.00	57.00	60.00
TF04 - Back total height from HSP	61.00	63.00	65.00	67.00	69.00	71.00
TG02 - Long sleeve length	60.00	61.00	62.00	63.00	64.00	65.00

KARIBAN

K4031

Ecologische damessweater met capuchon en ritssluiting

Kleurinformatie

 Ash Heather RVB : Pantone C : Based on Warm gray 1C Pantone TCX : Based on 13-4108TCX	 Black RVB : 35,35,37 Pantone C : Black Pantone TCX : 19-4004TCX	 Clay RVB : 188,180,174 Pantone C : 7535C Pantone TCX : 15-4502TCX	 Dark Grey RVB : 63,60,60 Pantone C : 447C Pantone TCX : 19-0000TCX	 Forest Green RVB : 41,62,48 Pantone C : 5605C Pantone TCX : 19-5918TCX
 Light Orange RVB : 240,119,60 Pantone C : 7578C Pantone TCX : 17-1360TCX	 Light Royal Blue RVB : 53,95,151 Pantone C : 653C Pantone TCX : 18-4041TCX	 Navy RVB : 41,46,56 Pantone C : 433C Pantone TCX : 19-4012TCX	 Oxford Grey RVB : Pantone C : Based on Cool gray 7C Pantone TCX : Based on 16-3850TCX	 Red RVB : 195,32,54 Pantone C : 200C Pantone TCX : 19-1664TCX
 Sage RVB : 153,172,163 Pantone C : 5635C Pantone TCX : 16-5304TCX	 White RVB : 236,236,252 Pantone C : White Pantone TCX : 11-0601TCX			

Logistieke informatie

 5  20

Sizes	Width (cm)	Height (cm)	Length (cm)	Net weight (kg)	Gross weight (kg)	Pieces/Box	Pieces/Bundle
XS	40.00000	32.00000	60.00000	8.90000	10.50000	20	5
S	40.00000	32.00000	60.00000	9.50000	11.10000	20	5
M	40.00000	32.00000	60.00000	10.10000	11.70000	20	5
L	40.00000	34.00000	60.00000	10.90000	12.50000	20	5
XL	40.00000	34.00000	60.00000	10.90000	13.00000	20	5
XXL	40.00000	34.00000	60.00000	11.80000	13.60000	20	5